

Chapa magnética de 1200LBS

Modelo: MAG1200NLED

Especificaciones

Dimensiones	265 x 73 x 41 (mm)
Fuerza de sujeción	1200Lbs(500Kgs)
Voltaje	12V CD o 24V CD
Corriente	12V/500mA o 24V/250mA
Para uso en	Puerta de seguridad, puerta de hierro, puerta de aluminio.
Temperatura de operación	-10~+55°C
Peso	4.5Kg

Diagrama

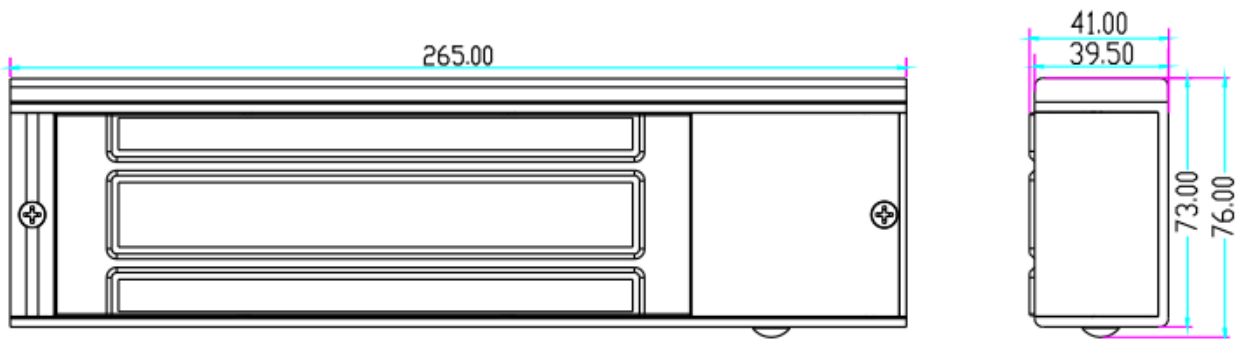

Pasos de instalación:

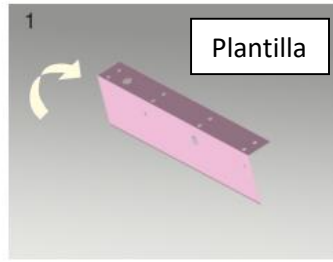
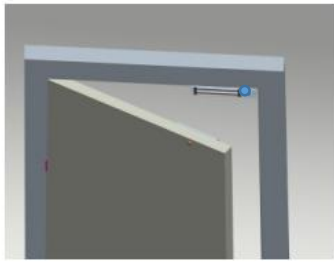

Doblar la plantilla.

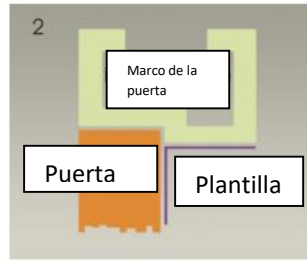

Cierre la puerta y ajuste la plantilla.

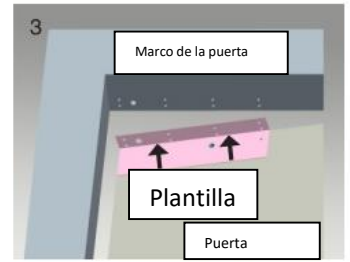

Perforar usando la plantilla.

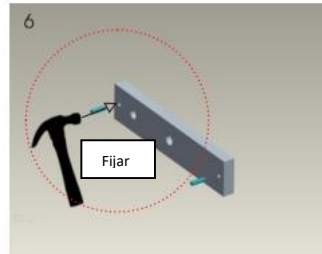
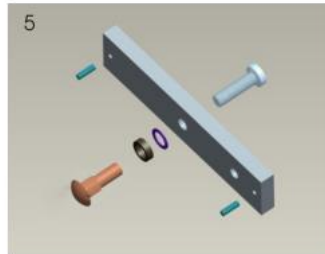
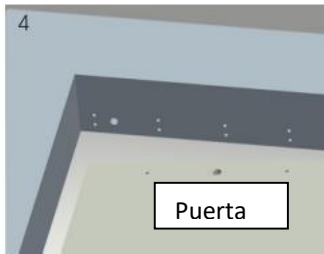

Fije los pines.

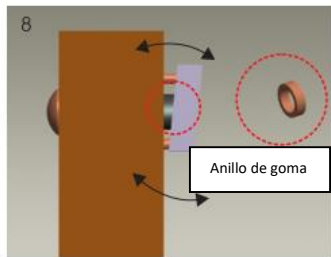
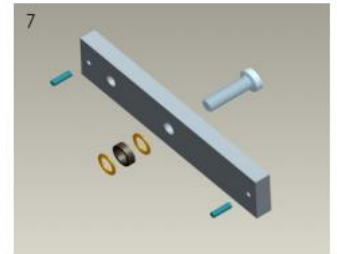

Coloque el anillo de goma entre la placa y la puerta.

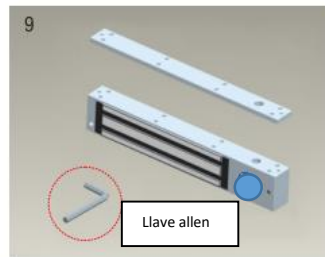

Desmonte el montaje en "I".

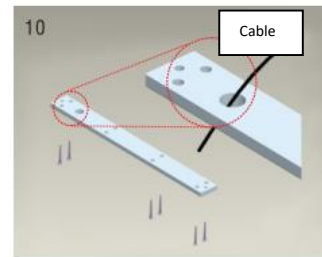

Acomode el cable por la perforación

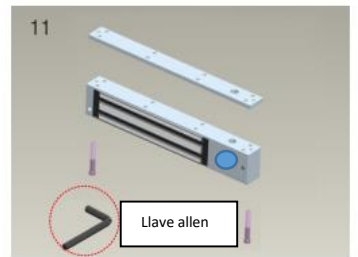

Ajuste los opresores con la llave.

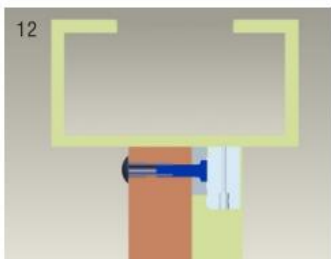

Cierre la puerta para probar la fuerza de sujeción. El ángulo entre la placa y el magnético se puede ajustar agregando o reduciendo las arandelas.

Terminales de conexión

